

Stretch Ceiling Solutions



Why Waverley?

Waverley have been appointed official dealers for Barrisol in London and the South East.

With a highly accomplished team of factory trained installers and a technical and sales team that have many years' experience with delivering complex stretch ceiling projects, we would be delighted to engage with you to provide a best-in-class service to architects, interior designers, contractors and end clients.

Why Barrisol?

Barrisol are by some distance the world market leaders in stretch ceiling technology. Their constant innovation and obsession with quality has enabled them to build an unrivalled brand presence in the market. No other stretch ceiling manufacturer comes close.

Why choose a Stretch Ceiling?

- Bring out your creativity and adapt to any form, situation or place
- Optimal acoustic performance up to α_w 1.0
- Incorporate lighting to bring the ceiling to life and create stunning room sets
- Suitable for use in moist environments – eg. over swimming pool areas
- A highly sustainable option compared to other ceiling types and can be 100% recycled at the end of its life
- Low maintenance and can be taken down and reinstalled with ease should access be required to any items above the ceiling
- With more than 20 unique system offerings and over 200 different finishes, including printing options, there truly is a Barrisol Stretch ceiling to suit every application

We'll be glad to help with more information or discuss your project.

Contact us on 01252 737973
barrisol@waverley.co.uk

All images are provided by Barrisol and are not of specific projects completed by Waverley.

Product Overview



Traditional

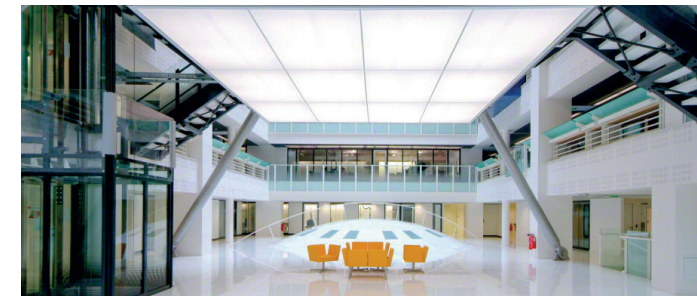

Illuminated

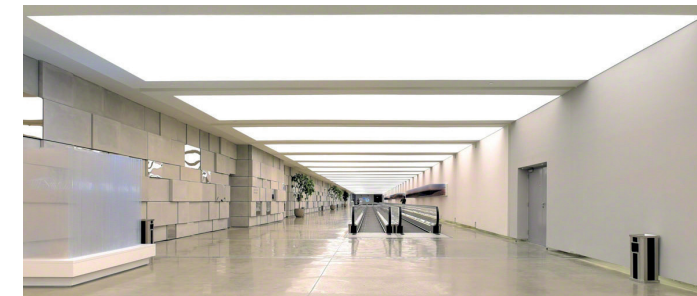

Acoustic



Printed

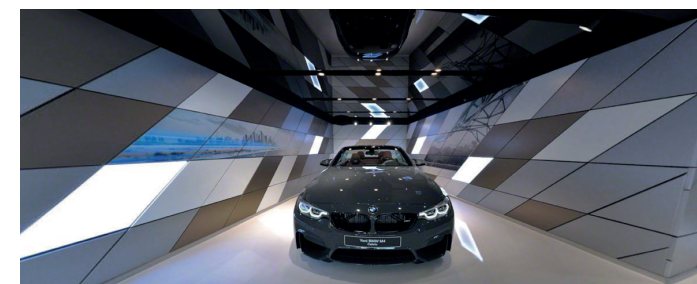

Mirror

Traditional Stretch Ceiling

A Barrisol Stretch Ceiling is a suspended ceiling system consisting of two basic components – a perimeter track and lightweight fabric membrane which stretches and clips into the track.



The perimeter is secured to the wall and the room is heated to approx. 40 degrees. The membrane is carefully secured to the trim with a harpoon system that is pre-welded onto the membrane in the factory. As the temperature returns to normal, the material contracts which gives the ceiling a perfectly flat, smooth finish.

There are a large number of profiles and trims to suit every application together with a comprehensive range of accessories available where penetrations are required eg. for downlighters, air conditioning vents, smoke alarms, sprinkler heads etc.



Common Profile Details

Ref: BS 350/01

Aluminium track

Weight: 0.235kg/ml

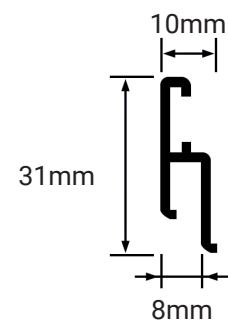

Ref: BS 350/11

Aluminium wall track

Weight: 0.241kg/ml

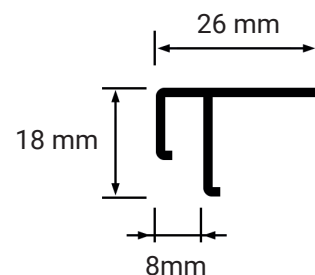

Seperator Profiles

Ref: BS 350/21

Aluminium seperator 6mm

Weight: 0.483kg/ml

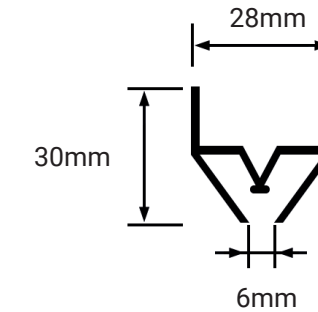

Ref: BS 350/23

Aluminium seperator

Weight: 0.472kg/ml

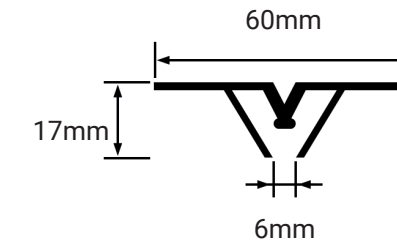

Finishes

There are over 230 different colours and 15 finishes, the principal ones of which can be broadly categorised as:

High Gloss
 Satin
 Matt

Contact us for a full swatch



Illuminated Stretch Ceiling

Combining lighting with a stretch ceiling produces stunning results. We work closely with lighting designers to create ambient, diffused light levels with maximum impact from the light source placed behind the membrane. Barrisol's illuminated ceilings utilise separate translucent and diffusing layers of membrane to create uniform and even light diffusion.

Illuminated ceilings can be fixed from wall-to-wall or recessed to produce a special feature in the ceiling or even as a wall panel.



Light Lines[®]

Barrisol Light Lines transform how spaces are illuminated. The creative and adaptable profiles along with the reduced power consumption help to achieve a clean, energy efficient lighting line. The concealed integration within the full range of Barrisol stretch products ensure sleek lighting systems are provided without the requirement for additional diffusers.



Common Profiles

Ref: BMS 340/10

Aluminium track for double layer lighting ceiling

Weight: 0.564kg/ml

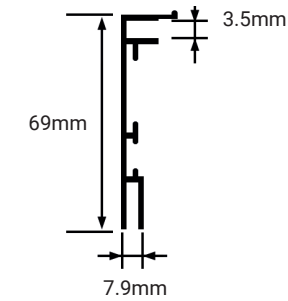

Ref: BS 350/21

Aluminium separator 6mm

Weight: 0.483kg/ml

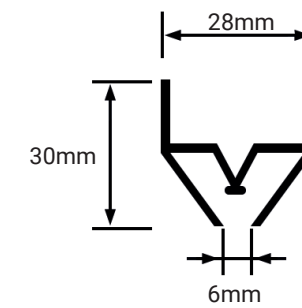

Ref: BS 350/24

Light separator

Weight: 1.871kg/ml

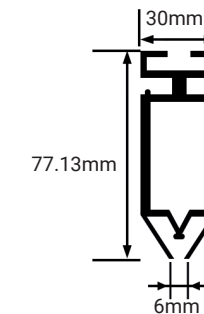

Ref: BMS 365/50

LED wall and ceiling separator

Weight: 2.153kg/ml

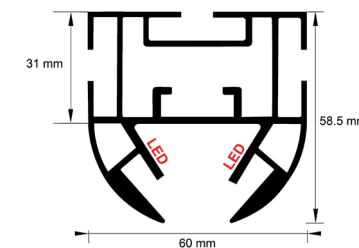

Finishes

Contact us for full details of the Lighting finishes available

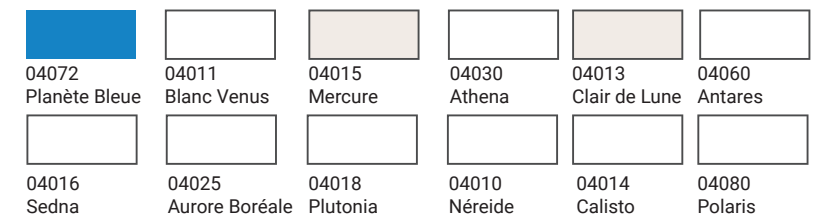

Acoustic Stretch Ceiling

Barrisol Acoustic stretch ceilings are available in four configurations and are highly effective in reducing reverberation and improving sound. They can be used with an air gap or in conjunction with an insulation material for further effectiveness.

The NanoPerf[®] option provides class leading acoustic performance combined with aesthetically minimal perforation.

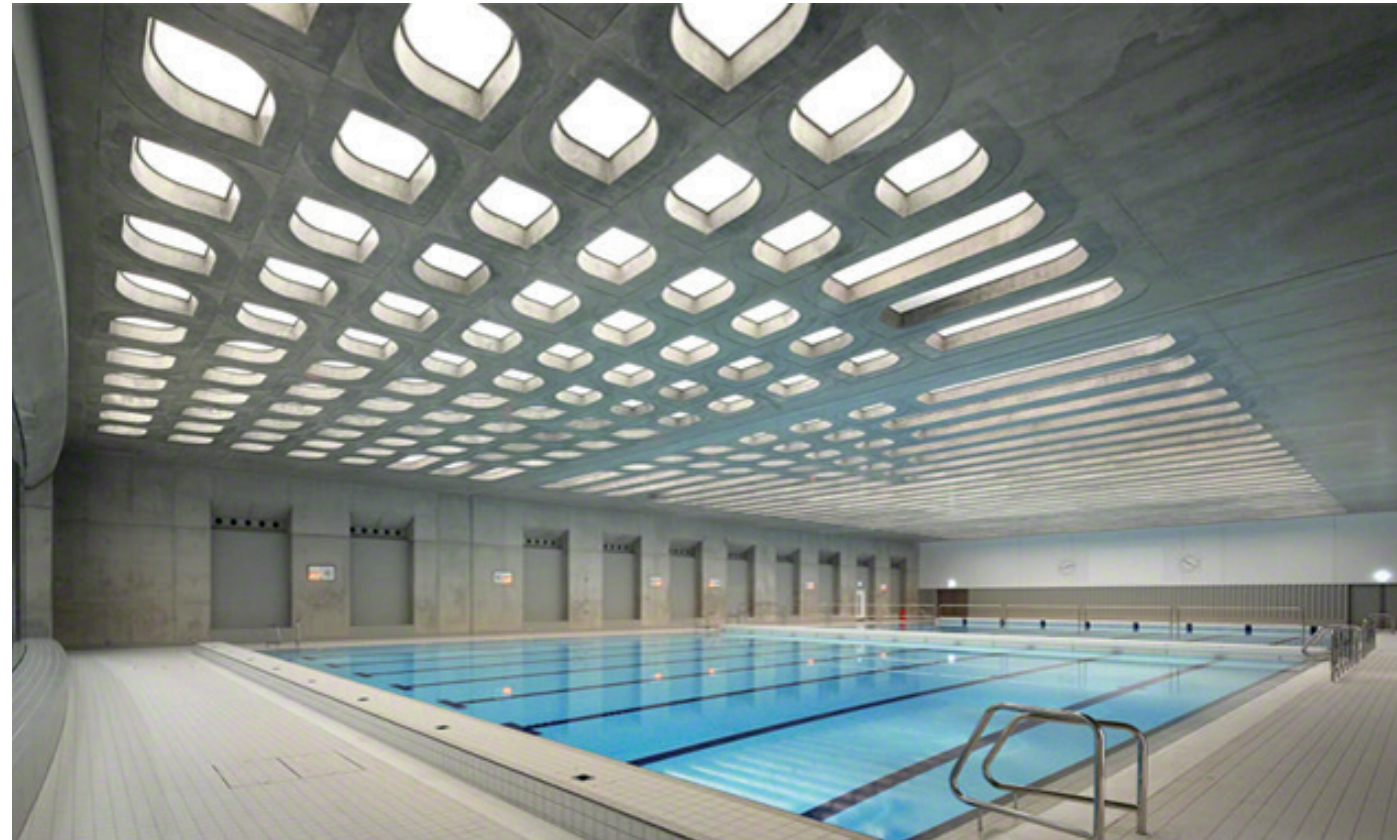

A15 NanoPerf[®]

Features

Holes: 500,000/m²
 Hole diameters: 0.1mm
 Perforation rate: 1%
 Thickness: 0.18mm
 Reference: A15+ref colour

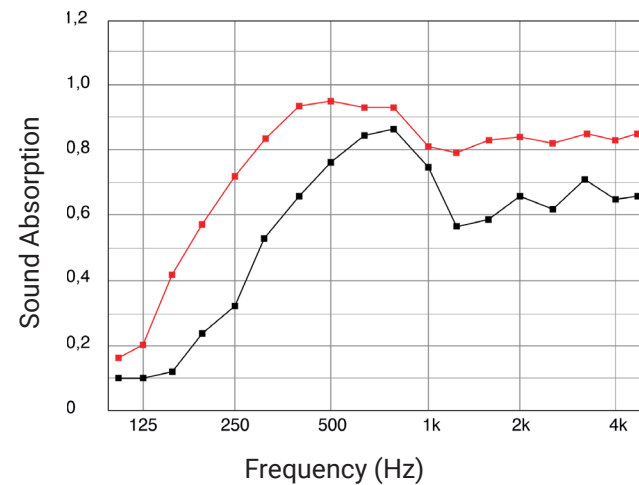
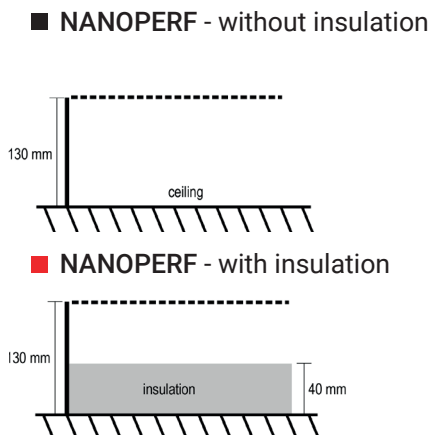

A20 AcoPerf[®]

Features

Holes: 400,000/m²
 Hole diameters: 0.15mm
 Perforation rate: 0.8%
 Thickness: 0.18mm
 Reference: A20+ref colour

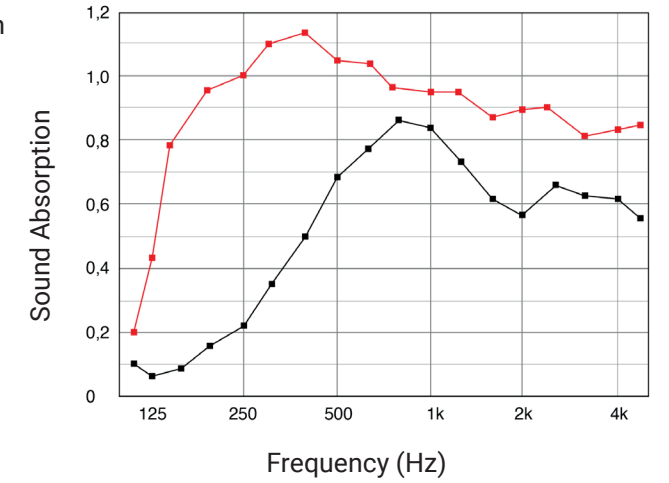
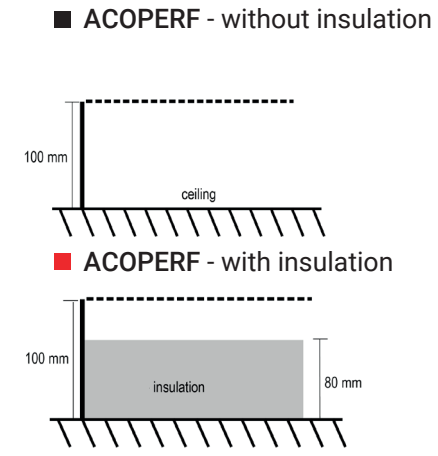

A30 MicroAcoustic[®]

Features

Holes: 300,000/m²
 Hole diameters: 0.2mm
 Perforation rate: 0.6%
 Thickness: 0.18mm
 Reference: A30+ref colour

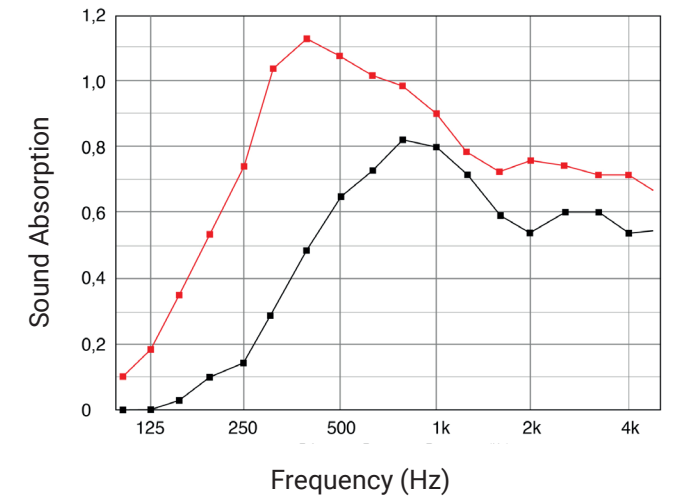
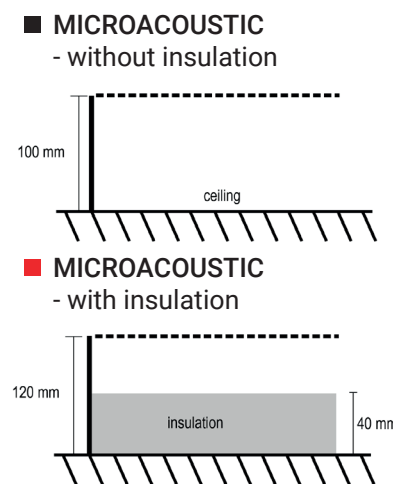

A40 MiniPerf[®]

Features

Holes: 30,000/m²
 Hole diameters: 0.5mm
 Perforation rate: 0.6%
 Thickness: =0.30mm
 Reference: A40+ref colour

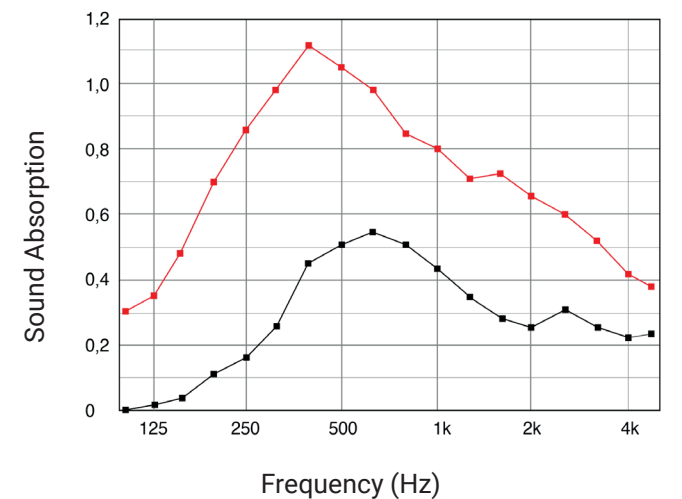
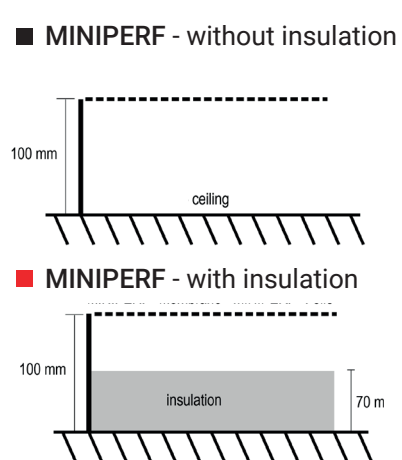

Printed Stretch Ceiling and Walls

The only limit is your imagination! Barrisol will take care of the rest. Combine with lighting and acoustic performance to create amazing spaces. Quick and clean to install.

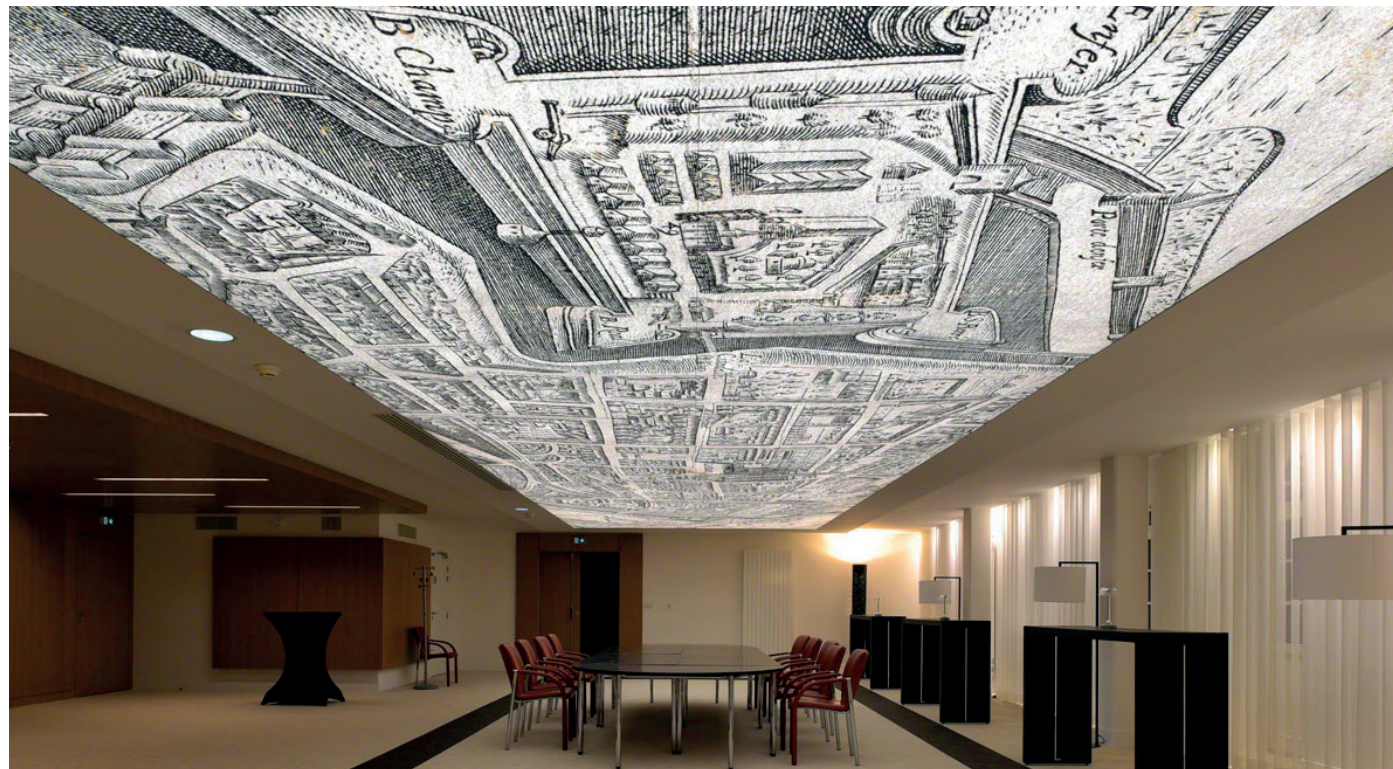

Images need to be 1/10 of the final ceiling size, supplied in a TIFF, JPEG or EPS format and must be a minimum of 300 dpi

Mirror Stretch Ceiling

Barrisol Mirror ceilings are specially designed to be mounted on free-standing frames of any shape.

Remarkably, Barrisol Mirror[®] combines the reflective power of a mirror and the technical characteristics of stretched Barrisol[®] membranes to create a perfect illusion and gives the impression of space in any interior.

Also available as printed, Barrisol Mirror[®] membrane can use an exclusive micro-perforation system to enhance the acoustic comfort in any space. It can also be combined with lighting using a macro perforated system.

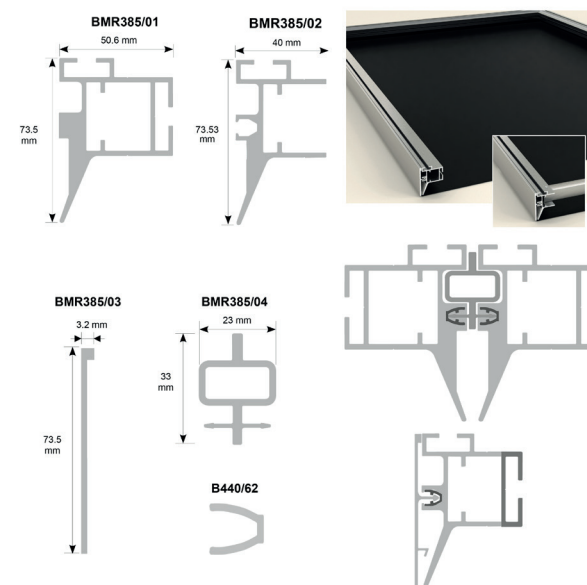

Finishes

	
BHMS 1 Mirror Silver	BHMG 1 Mirror Gold
	
BHMC 2 Mirror Copper	BHMN 1 Mirror Black
	
BHME 1 Tin Moiré	BHMC 1 Copper Moiré

