

Hand Operated Curtain Track System

Silent Gliss[®] 6970

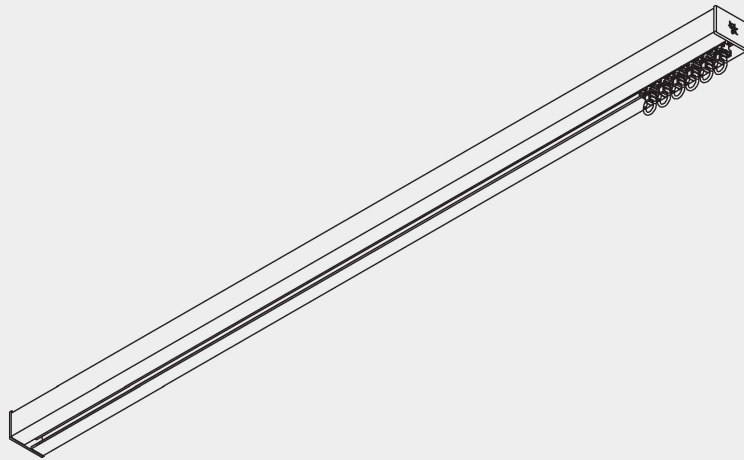

Product Information

- Operation: hand drawn
- Range: L
- Fitting: ceiling, wall, recess
- Colours: white
- Shape: square
- 2C glider technology
- Wave compatible
- Bendable (including recess profile)



6970

Profile and Bending Information

Profile

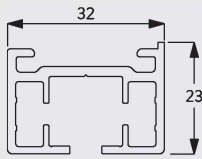

10850



Radius: >25 cm

Recess profile

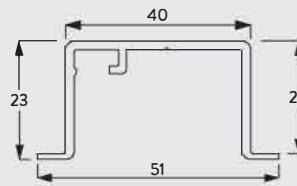

10862



Radius: >50 cm
Max. radius: 75 cm

Specification text:

Silent Gliss SG 6970 Hand Operated Curtain Track System. Comprises aluminium profile SG 10850 supplied made to measure available in silver anodised or powder coated in white. Supplied as standard with 2C roller gliders SG 10840 at 10/m, 2 end covers SG 11235 and 2 end stops SG 6007. Top fixed with fixing clamp SG 3004 at max. 500mm centres. Optional top fix with SG 3041 bracket or direct top fix with mounting plate SG 10865 and profile protector SG 7002. Wall fix with SG Smart Fix brackets SG 11201-11205 and SG 3041 or SG 3004 / SG Square Smart Fix brackets SG 11210-11215 and SG 3041 or SG 3004 / SG Universal Smart Fix brackets SG 11154-11156 and SG 3041 or SG 3004. Recess fix with recess profile SG 10862, recess masks SG 10864 and wedges SG 5118. Silent Gliss Wave option is available using 60mm glider cord 10869 / 80mm glider cord SG 10852.

How To Measure

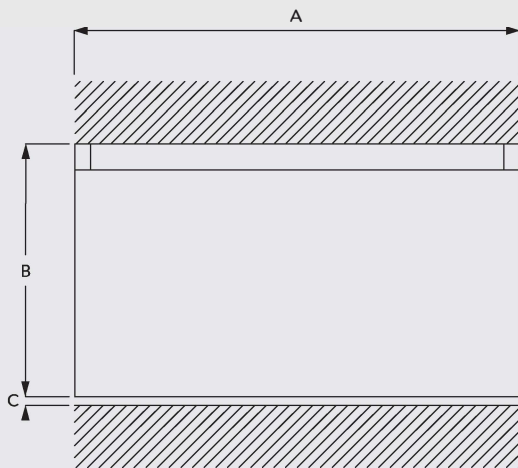

A: System width
B: System height
C: Distance between floor and fabric

System Options

Wave Curtain Heading System

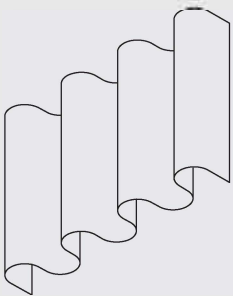

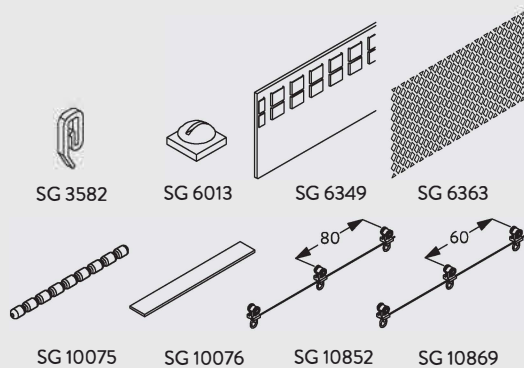

The Wave standard components are:

- 10869 Wave 2C Glider Cord 60mm
- 10852 Wave 2C Glider Cord 80mm
- 6007 End stop

Optional components to improve the presentation of the curtain:

- 3582 Hook
- 6349 Curtain tape
- 6363 Iron-on top hemming tape
- 10075 Lead weight for hem of curtain 50gr/m
- 10076 Fabric weight for side edge of curtain

Fitting Information

Fixing Points

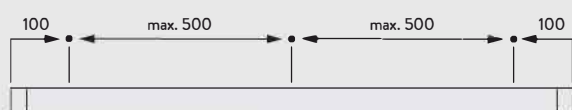

Fitting Options

Ceiling fitting with direct mounting

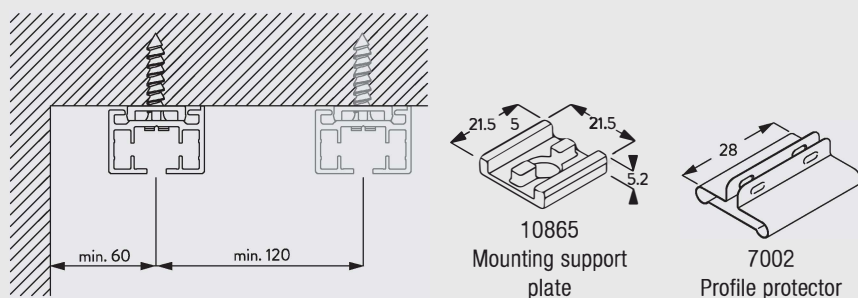

Ceiling fitting with clamp SG 3004

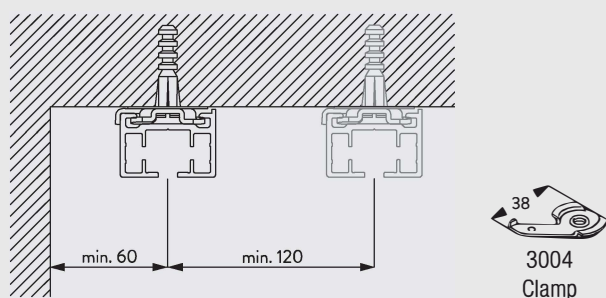

Wall fitting with Smart Fix SG 11200-11205 and bracket SG 3041

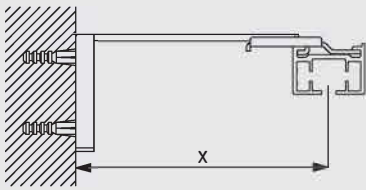

	X (mm)
11200	83
11201	103
11202	123
11203	143
11204	173
11205	223

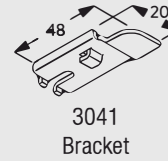
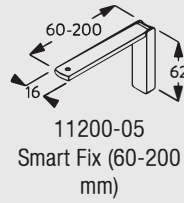

Brackets threaded for screw M4 x 8

Wall fitting with Square Smart Fix SG 11210-11215 and bracket SG 3041

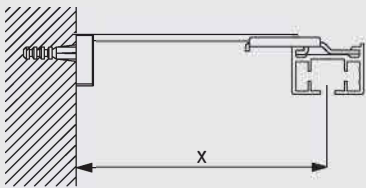

	X (mm)
11210	83
11211	103
11212	123
11213	143
11214	173
11215	223

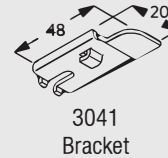
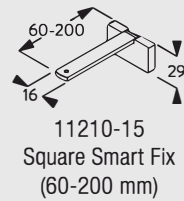

Brackets threaded for screw M4 x 8

Wall fitting with Universal Smart Fix SG 11154-11156 and bracket SG 3041

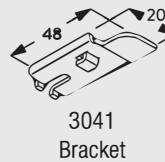
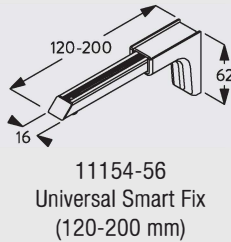
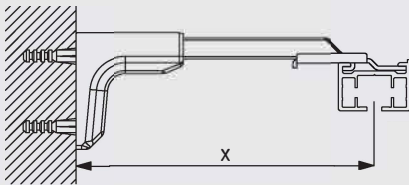

Brackets threaded for screw M4 x 8

Wall fitting with Smart Fix SG 11201-11205 and clamp SG 3004

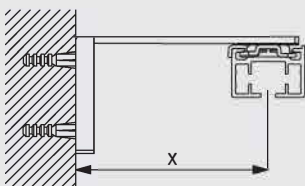

	X (mm)
11201	72
11202	92
11203	112
11204	142
11205	192

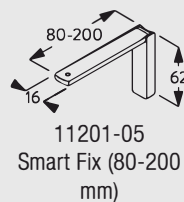

Brackets threaded for screw M4 x 8

6970

Wall fitting with Square Smart Fix SG 11211-11215 and clamp SG 3004

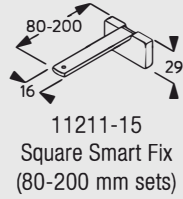
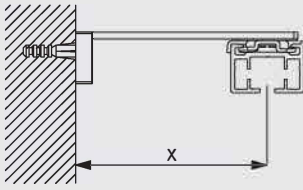

Brackets threaded for screw M4 x 8

Wall fitting with Universal Smart Fix SG 11154-11156 and clamp SG 3004

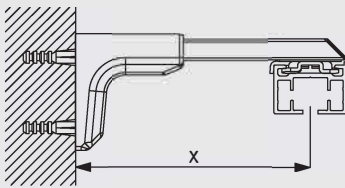

	X (mm)
11154	102-130
11155	132-160
11156	182-210

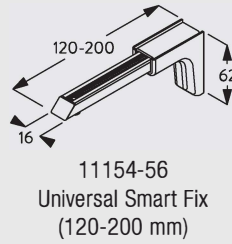

Brackets threaded for screw M4 x 8

Recess fitting with recess profile SG 10862

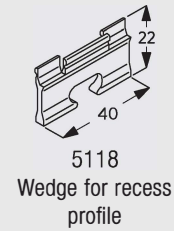
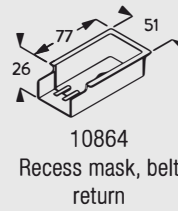
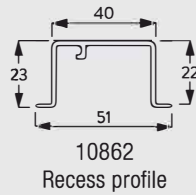
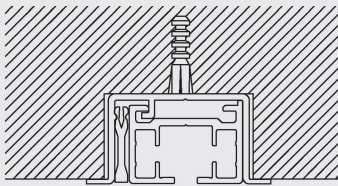





6970

Standard Accessories

3004	Clamp		6007	Endstop	
10840	Two component roller		10850	Profile	
11235	End cover				

Optional Accessories

3582	Hook		5118	Wedge for recess profile	
6007	Endstop		7002	Profile protector	

10407 Pan head screw M4x10



10431 Draw rod with hook, 75cm



10433 Draw rod with hook, 125cm



10831 Connecting bridge



10864 Recess mask, belt return



11154 Universal Smart Fix, 120 mm set



11156 Universal Smart Fix, 200 mm set

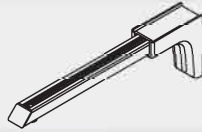

11201 Smart Fix, 80 mm set



11203 Smart Fix, 120 mm set



11205 Smart Fix, 200 mm set



11211 Square Smart Fix, 80 mm set



11213 Square Smart Fix, 120 mm set



11215 Square Smart Fix, 200 mm set

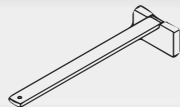

10430 Draw rod with hook, 50cm



10432 Draw rod with hook, 100cm



10434 Draw rod with hook, 150cm



10862 Recess profile



10865 Mounting support plate



11155 Universal Smart Fix, 150 mm set

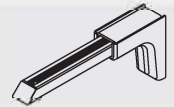

11200 Smart Fix, 60 mm set



11202 Smart Fix, 100 mm set

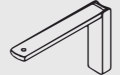

11204 Smart Fix, 150 mm set



11210 Square Smart Fix, 60 mm set



11212 Square Smart Fix, 100 mm set



11214 Square Smart Fix, 150 mm set

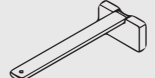

Wave Accessories

6349 Curtain tape



10075 Lead weight 50 gr/m



10852 Wave roller cord (80mm), 6.5mm channel



6363 Top hemming tape



10076 Fabric weight



10869 Wave roller cord (60mm), 6.5mm channel



6970