

Hand Operated Curtain Track System

Silent Gliss® 3840W

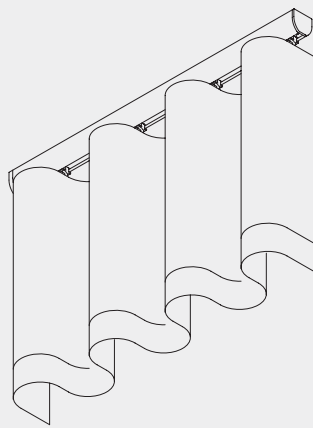

Product Information

- For use with Wave Standard and Wave XL curtain heading systems.
- Purpose designed for ceiling fixing - neat attractive track.
- Ideal for contract or domestic use.
- Same appearance from both sides.
- Standard length 6m, can be joined.
- Standard colours: silver, white, gold, bronze, black.
- For medium weight curtains.
- Can be bent.



3840W

Profile, Bending and Specification Information

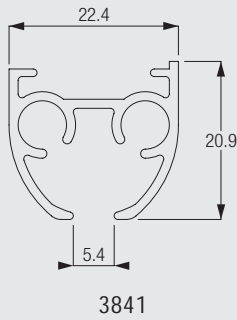

 Standard radius 200mm
 Wave XL: Min. radius 500mm

Note: It is important to observe the minimum bending radius for Wave XL. The system will not function with a smaller radius.

Specification Guide - download from www.silentgliss.co.uk (password required).

Silent Gliss 3840W curtain track, hand drawn, anodised aluminium, assembled complete with wave glider-cord 6345/6346. Top fix with special fixing clamp 3825/special fixing bracket 3832 at max 600mm. centres each screwed to timber/plugged and screwed to block/concrete. Lm.

How To Measure

Stack depth Wave Standard

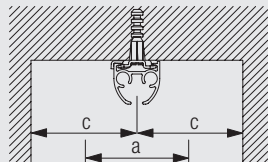
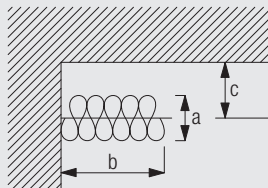

a = Stack depth
 b = Stack size
 c = Min. distance

Glider-cord spacing	Curtain hook spacing	Approx. curtain fullness	Stack depth (a)	Stack width (b)	Min distance (c)
6	10	1.9	10	23 per metre of track + endpiece	9.5
6	12	2.2	12	23 per metre of track + endpiece	10.5
8	14	2.0	12	18 per metre of track + endpiece	11.5
8	16	2.2	12	18 per metre of track + endpiece	12.5



(dimensions in cm)

Note: Minimum distance (c) includes a standard 4.5cm clearance (front and back).

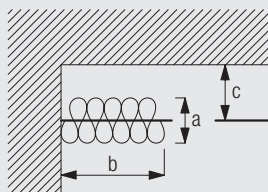
Stack Size calculation Wave XL

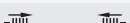

a = Stack depth 35cm
 b = Stack size
 c = Min. distance 22cm

System width		77-107	108-143	144-179	180-215	216-251	252-287	288-323	324-359	360-395
	b	28	33	38	43	48	53	58	63	68
System width		396-431	432-468	469-503	504-539	540-575	576-600			
	b	73	78	83	88	93	98			
System width		154-217	218-289	290-361	362-433	434-505	506-577	578-600		
	b	28	33	38	43	48	53	58		

(dimensions in cm)

System Options

Wave Standard curtain heading system

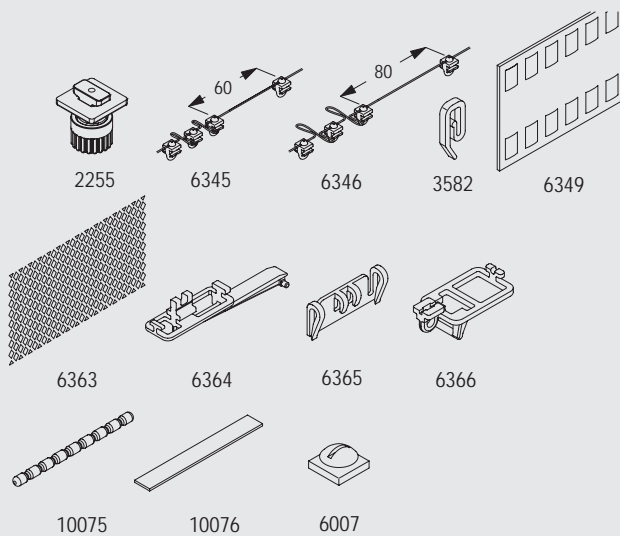
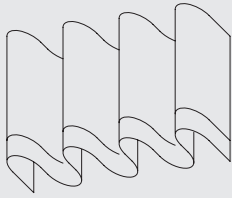

Wave is an exciting new contemporary curtain heading system which allows curtains to hang in a continuous wave which is smooth, simple and elegant.

The Wave standard components are:

6345 Glider Cord 60mm
6346 Glider Cord 80mm
3582 Hook
6349 Curtain tape
6363 Iron-on top hemming tape
6007 End stop

Additional optional Wave components:

2255 Adjustable brake
6364 Extension (used with 6365)
6365 Hanger (used with 6364)
6366 Carrier for draw rod
10075 Lead weight for hem of curtain 50gr/m
10076 Fabric weight for side edge of curtain

Wave XL curtain heading system

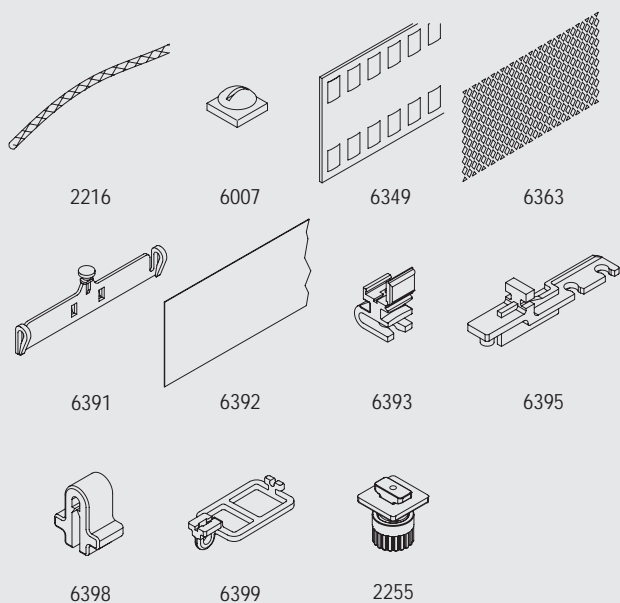
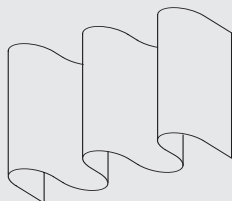

Wave XL is especially designed for high and large application areas through generously designed waves with large cross section dimensions.



The Wave XL components are:

2216 Cord 0.85 mm
2255 Adjustable brake
6007 End stop
6349 Curtain tape
6363 Iron tape
6382 Limit stop
6391 Hanger
6392 Heading film
6393 Glider
6394 Carrier
6395 Extension
6398 Clip
6399 Carrier for draw rod

Fitting Information

Bracket and profile Positioning

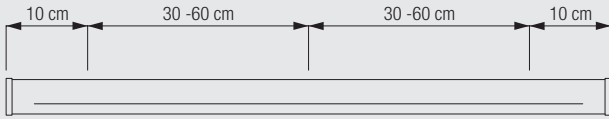

The fixing distances above are a guide only: they may vary in practice depending on surface and curtain weight.

Handling of fixing clamp 3825

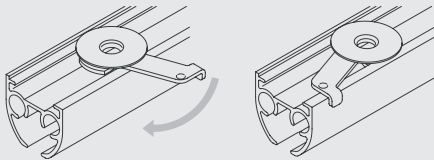

Higher edge of profile to the room side.
Clamp arm to the window.

Handling of fixing bracket 3832

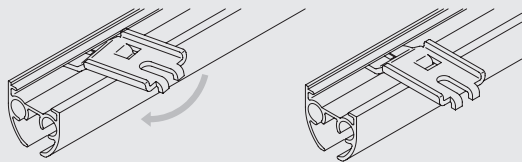

Higher edge of profile to the room side.

Fitting Options



3840W

Ceiling fix with clamp 3825

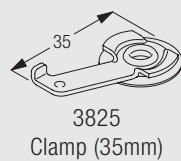
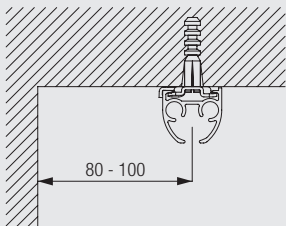

3825
Clamp (35mm)

Min. distance from wall when using Wave XL: 220mm.

Ceiling fix with bracket 3832

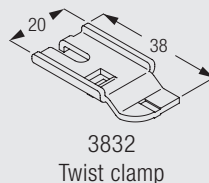
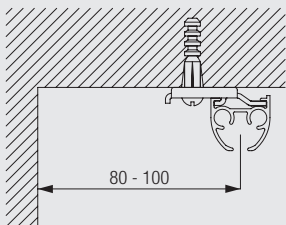

3832
Twist clamp

Min. distance from wall when using Wave XL: 220mm.

Ceiling fix with bracket 3826

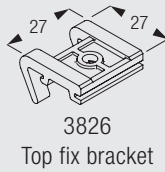
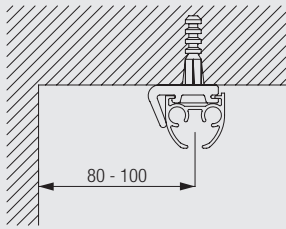

Min. distance from wall when using Wave XL: 220mm.

Wall fix with brackets 3134-39 and bracket 3826

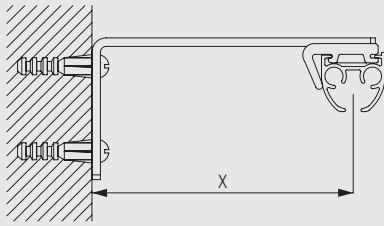

	x (mm)	W (mm)	Y (mm)	Z (mm)
3134	n/a	n/a	n/a	n/a
3135	72	-	50	50
3136	92	-	50	50
3137	112	-	80	50
3138	142	60	80	60
3139	192	85	80	85

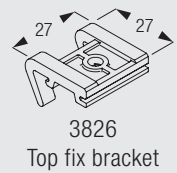
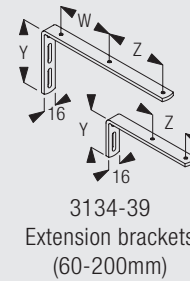

The distances identified in ALL of the fitting options above may vary depending on the Wave heading requirements. Please refer to the Wave Curtain Make-up Guide (available at www.silentgliss.co.uk) for exact measurements.

Wall fix with adjustable brackets 3275-77

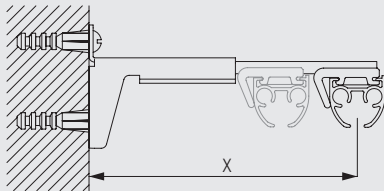

	x (mm)
3275	94
3276	116
3277	146

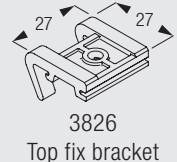
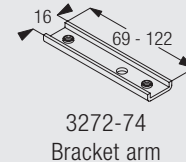
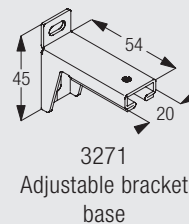

The distance may vary depending on the Wave heading requirements. Please refer to the Wave Curtain Make-up Guide (available on the Silent Gliss Extranet) for exact measurements.

Standard Accessories

3825 Clamp (35mm)



3841 Profile



3842 End cover



6007 Endstop



6064 Screw twist endstop



6345 Wave glider cord (60mm)





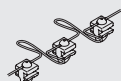









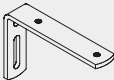
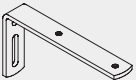
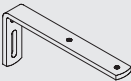
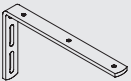
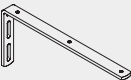

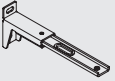

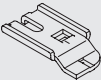



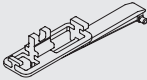

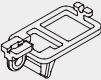

6346 Wave glider cord (80mm)

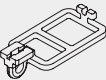
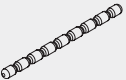

1148C Countersunk screw

Optional Accessories

2216	Cord		2255	Adjustable brake	
3133	Bracket cover (60mm)		3134	Extension bracket (60mm)	
3135	Extension bracket (80mm)		3136	Extension bracket (100mm)	
3137	Extension bracket (120mm)		3138	Extension bracket (150mm)	
3139	Extension bracket (200mm)		3275	Adjustable extension bracket set (69mm)	
3276	Adjustable extension bracket set (92mm)		3277	Adjustable extension bracket set (122mm)	
3582	Hook		3826	Top fix bracket	
3832	Twist clamp		6007	Endstop	
6349	Wave curtain heading tape		6363	Top hemming tape	
6364	Extension		6365	Hanger	
6366	Carrier for draw rod		6382	Limit stop	
6391	Hanger		6392	Heading film	
6393	Glider		6394	Carrier	
6395	Extension		6398	Clip	
6399	Carrier for Draw rod		10075	Lead weight 50 gr/m	
10076	Fabric weight		3133L	Extended bracket cover for 3138/9	

3840W